

# STEIDELE - Baustromverteiler

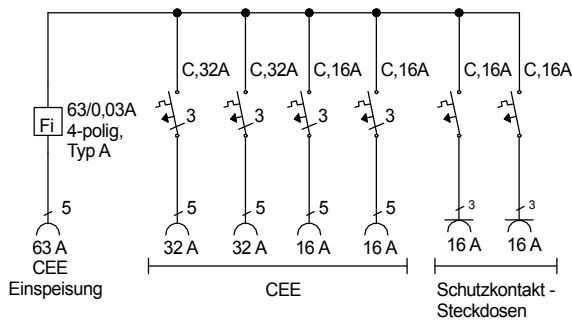
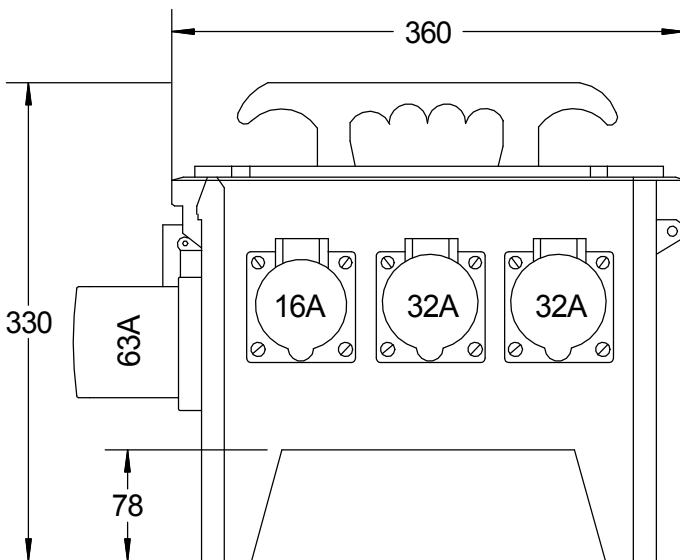
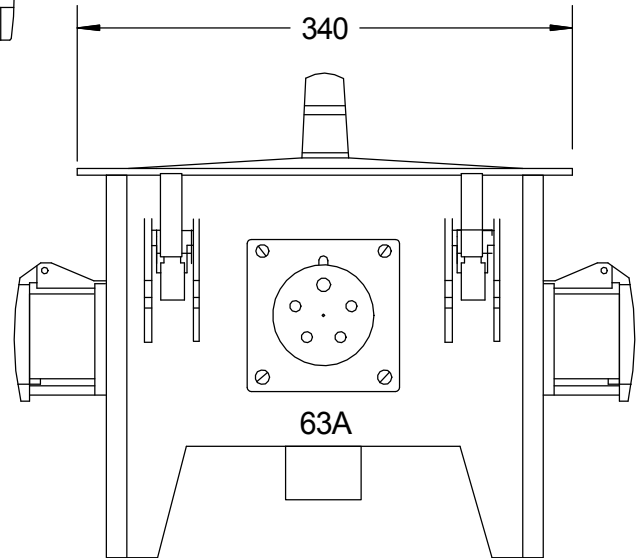
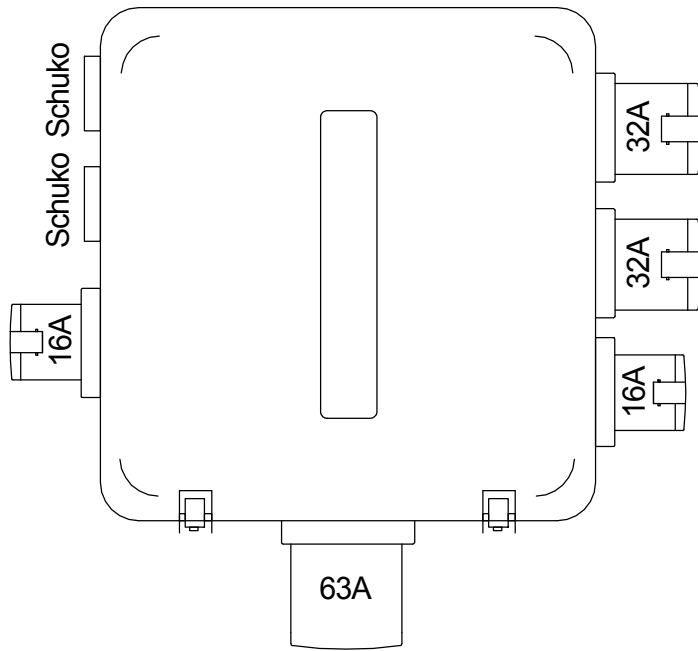
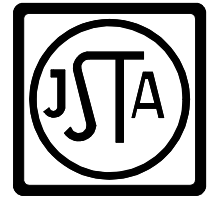

FI-Schalter Typ A sind nicht für den Betrieb  
Frequenzumrichter gesteuerter Betriebsmittel  
geeignet!

Typ:	SVG 63/22-2	Nr. 6260
Artikelgruppe:	Vollgummi-Steckdosenverteiler nach EN 61439-1	gezeichnet am/von:
Leistung:	44 kVA	24.08.2016 / Uffinger