

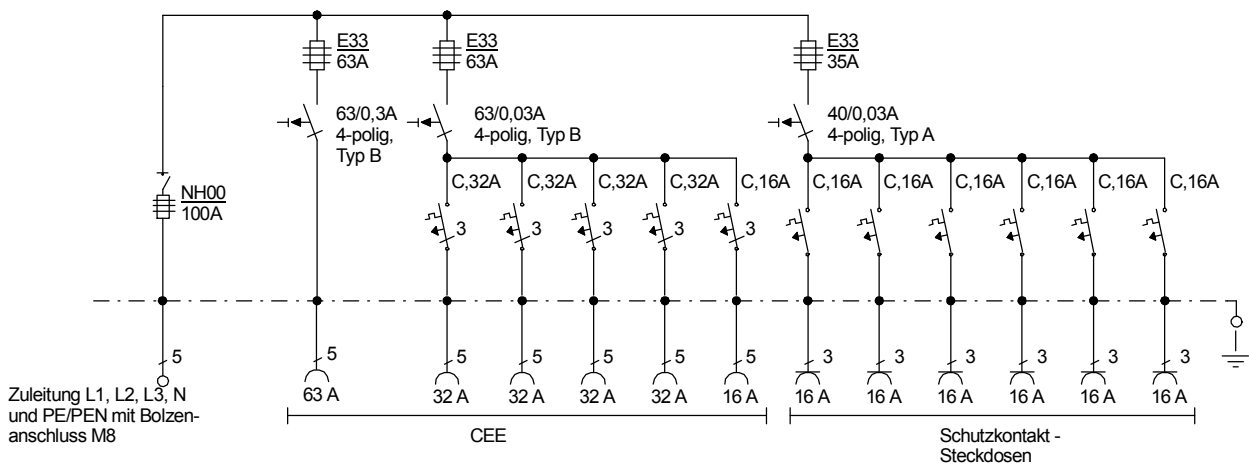

# STEIDELE

## Stromverteiler

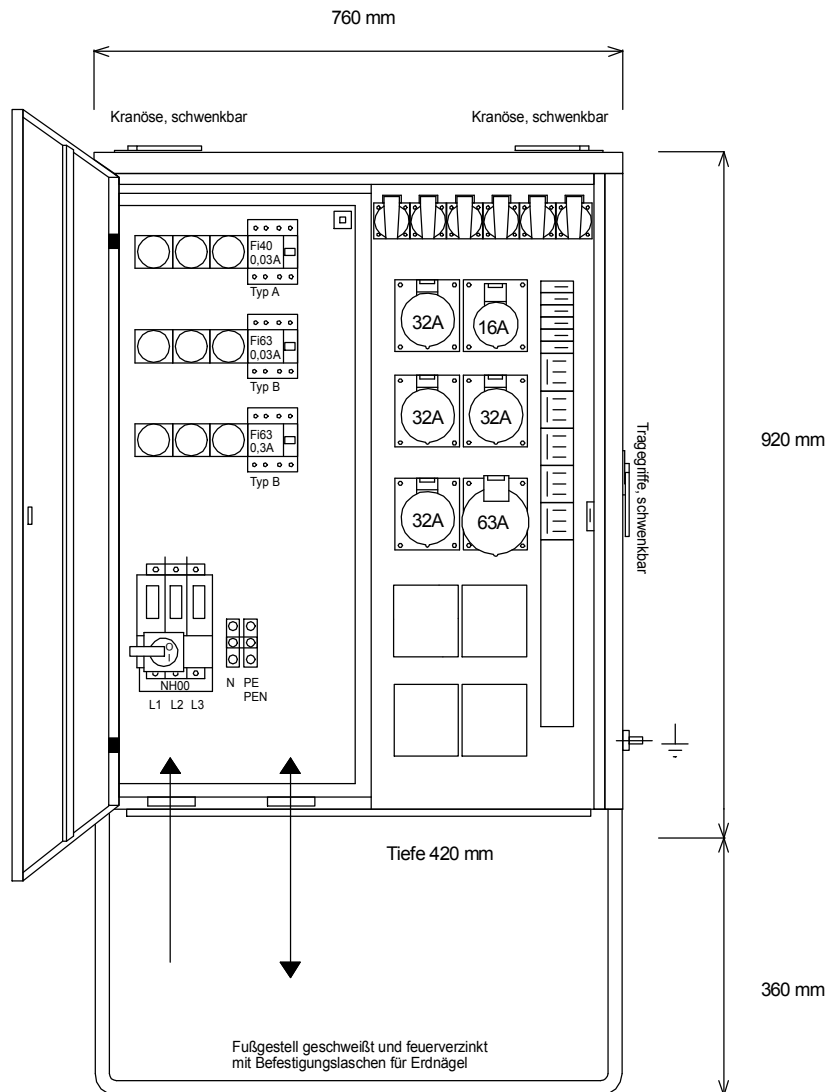

Entsprechend der neuen DIN VDE 0100-704/Okttober 2018

Typ: V 100.3/141-6

Best.Nr. 7340

Verteiler nach EN 61439-4

gezeichnet am/von:

Leistung 69 kVA, Gewicht ca. 68 kg, Gehäuse 13.7

27.03.2017 / Uffinger