

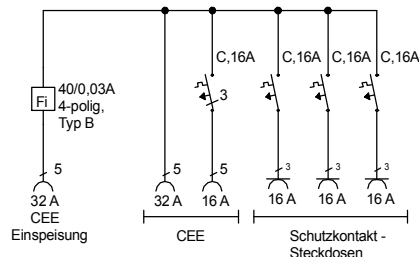

STEIDELE

Stromverteiler

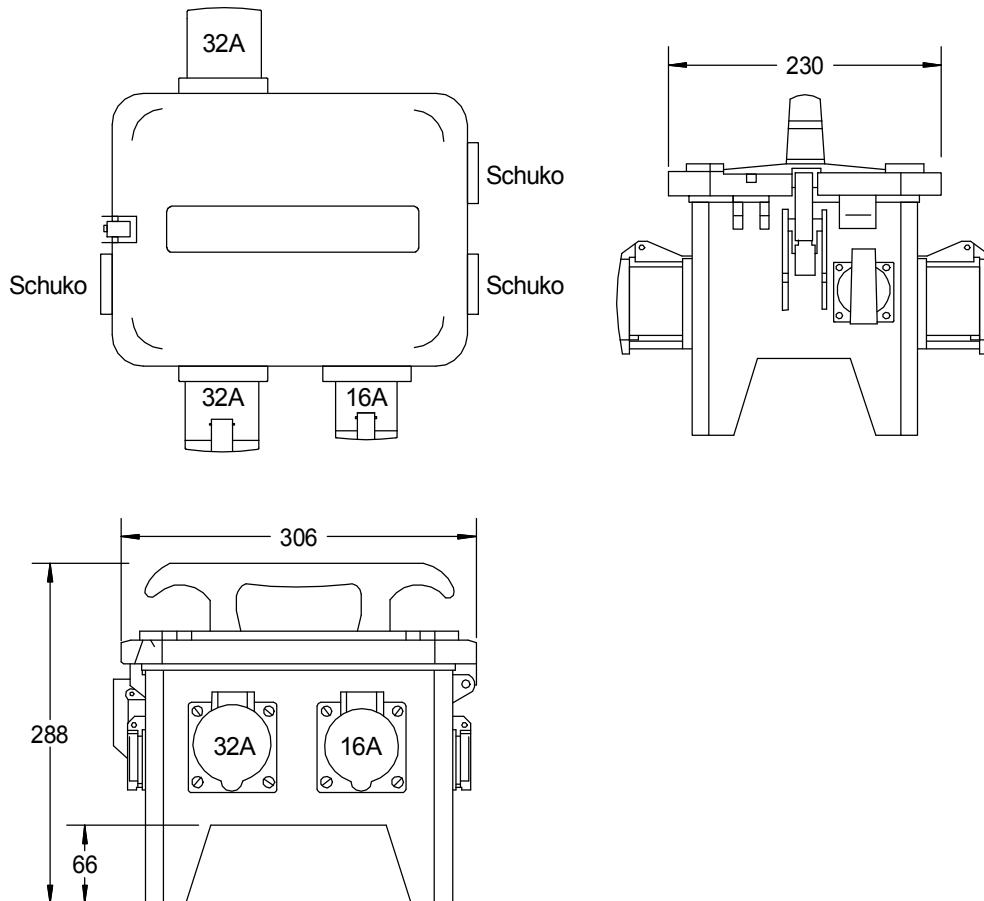
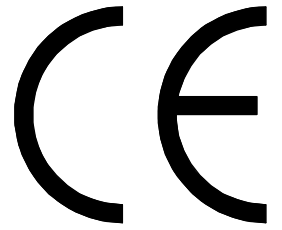

Entsprechend der neuen DIN VDE 0100-704/Okttober 2018

Typ: SVG 32.1/11-3

Best.Nr. 9180

Verteiler nach EN 61439-4

gezeichnet am/von:

Leistung 22 kVA, Gewicht ca. 7,2 kg

05.06.2019 / Uffinger